

МАКО СЕРВИЗ оод

Търговско представителство за инструменти и дървообработващи машини от Чехия

ЦЕНТРАЛЕН ОФИС: 5300 ГАБРОВО, бул. " Столетов " 131 тел. 066/800250, 801502, факс 801566
 моб. 088 8302483, 088 8678631; E-mail: office@pilana.bg

Офис : 8005 БУРГАС: ул. "Янко Комитов" 16А /до входа на "Елприбор"/ тел./факс 056/88 01 02
 моб. 088 9437608;

СТРУГАРСКИ НОЖОВЕ СЪС ЗАПОЕНИ ТВЪРДОСПЛАВНИ ПЛАСТИНИ

външно струговане

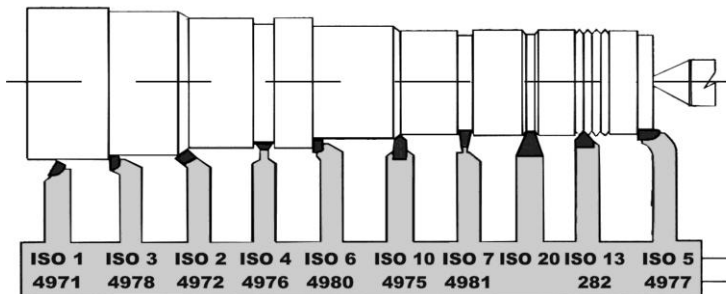

вътрешно струговане

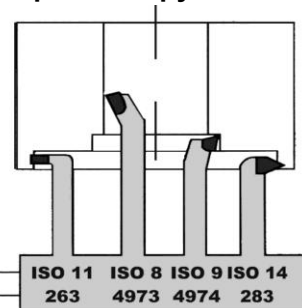

ISO 1 - Проходни прави 70

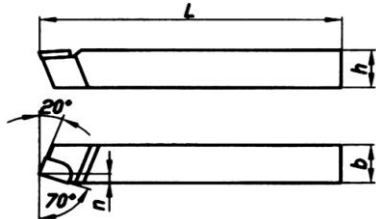

Размер	h x b x L	Цена (лв.)
0808R/L	8x8x90	
1010R/L	10x10x90	
1212R/L	12x12x100	
1616R/L	16x16x110	
2020R/L	20x20x125	
2525R/L	25x25x140	
3232R/L	32x32x170	
4040R/L	40x40x200	

ISO 2 - Проходни извити 45

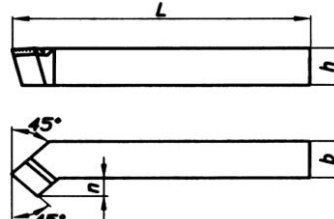

Размер	h x b x L	Цена (лв.)
0808R/L	08x08x90	
1010R/L	10x10x90	
1212R/L	12x12x100	
1616R/L	16x16x110	
2020R/L	20x20x125	
2525R/L	25x25x140	
3232R/L	32x32x170	
4040R/L	40x40x200	

ISO 3 - Проходни упорни 95

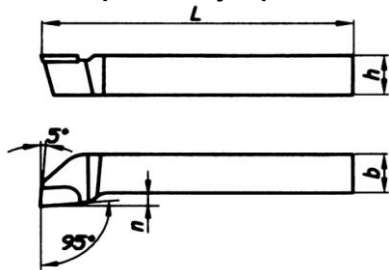

Размер	h x b x L	Цена (лв.)
0808R/L	8x8x90	
1010R/L	10x10x90	
1212R/L	12x12x100	
1616R/L	16x16x110	
2020R/L	20x20x125	
2525R/L	25x25x140	
3232R/L	32x32x170	
4040R/L	40x40x200	

ISO 4 - Чистови широки

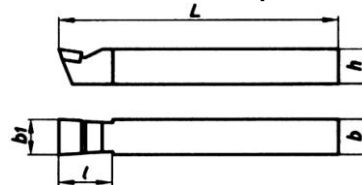

Размер	h x b x L	Цена (лв.)
0808R/L	8x8x90	
1010R/L	10x10x90	
1212R/L	12x12x100	
1616R/L	16x16x110	
2020R/L	20x20x125	
2525R/L	25x25x140	
3232R/L	32x32x170	
1610R/L	16x10x110	
2012R/L	20x12x125	
2516R/L	25x16x140	
3220R/L	32x20x170	
4025R/L	40x25x200	

ISO 5 - Челни

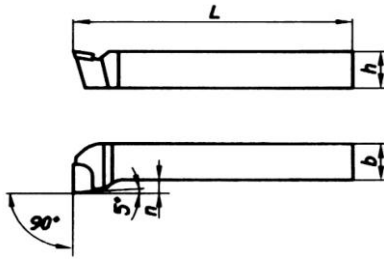

Размер	h x b x L	Цена (лв.)
0808R/L	8x8x90	
1010R/L	10x10x90	
1212R/L	12x12x100	
1616R/L	16x16x110	
2020R/L	20x20x125	
2525R/L	25x25x140	
3232R/L	32x32x170	
4040R/L	40x40x200	

ISO 7 - Прорезни и отрезни

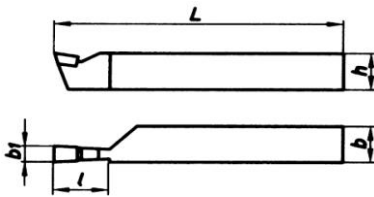

Размер	h x b x L	Цена (лв.)
1010	10x10x90	
1212	12x12x100	
1616	16x16x110	
2020	20x20x125	
2525	25x25x140	
3232	32x32x170	
1208	12x8x100	
1610	16x10x110	
2012	20x12x125	
2516	25x16x140	
3220	32x20x170	
4025	40x25x200	

ISO 9 - За глухи отвори

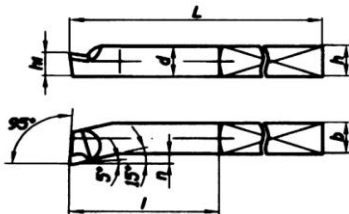

Размер	h x b x L	Цена (лв.)
0808	8x8x125	
1010	10x10x150	
1212	12x12x180	
1616	16x16x210	
2020	20x20x250	
2525	25x25x300	
3232	32x32x350	

ISO 6 - Проходни упорни 90

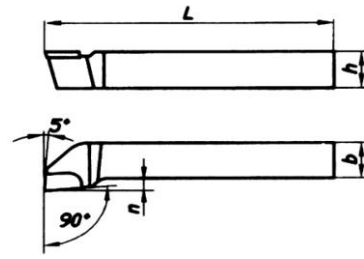

Размер	h x b x L	Цена (лв.)
0808R/L	8x8x90	
1010R/L	10x10x90	
1212R/L	12x12x100	
1616R/L	16x16x110	
2020R/L	20x20x125	
2525R/L	25x25x140	
3232R/L	32x32x170	
4040R/L	40x40x200	

ISO 8 - За проходни отвори

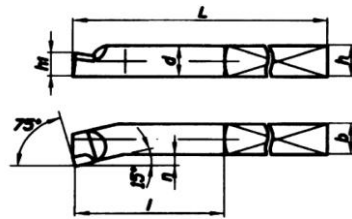

Размер	h x b x L	Цена (лв.)
0808	8x8x125	
1010	10x10x150	
1212	12x12x180	
1616	16x16x210	
2020	20x20x250	
2525	25x25x300	
3232	32x32x350	

ISO 10 - Шпиц

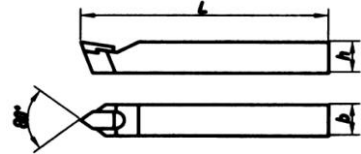

Размер	h x b x L	Цена (лв.)
1010	10x10x90	
1212	12x12x100	
1616	16x16x110	
2020	20x20x125	
2525	25x25x140	
3232	32x32x170	
1610	16x10x110	
2012	20x12x125	
2516	25x16x140	
3220	32x20x170	
4025	40x25x200	

ISO 11 - За вътрешни канали

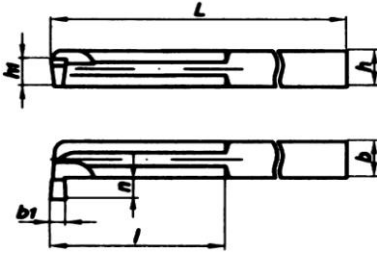

Размер	h x b x L	Цена (лв.)
1010	10x10x150	
1212	12x12x180	
1616	16x16x210	
2020	20x20x250	
2525	25x25x300	
3232	32x32x355	

ISO 13 - За външна резба

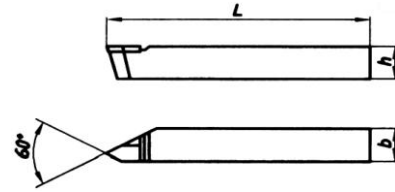

Размер	h x b x L	Цена (лв.)
1010	10x10x90	
1212	12x12x100	
1616	16x16x110	
2020	20x20x125	
2525	25x25x140	
3232	32x32x170	
1610	16x10x110	
2013	20x12x125	
2516	25x16x140	
3220	32x20x170	
4025	40x25x200	
1010	10x10x100	
1212	12x12x125	
1616	16x16x140	
2020	20x20x160	
2525	25x25x200	

ISO 14-Нож за вътрешна резба

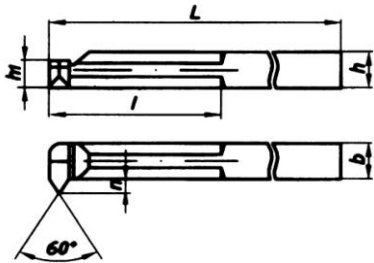

Размер	h x b x L	Цена (лв.)
1010	10x10x150	
1212	12x12x180	
1616	16x16x210	
2020	20x20x250	
2525	25x25x300	

ISO 20 - За трапецовидни канали

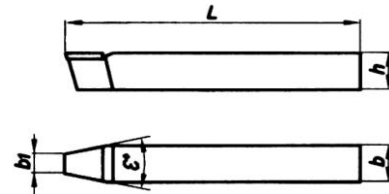

Размер	h x b x L	Цена (лв.)
1610	16x10x110	
2012	20x12x125	
2512	25x16x140	
3220	32x20x170	